



PACTO TOILET  
2016

**DANFO**



**PACTO®**

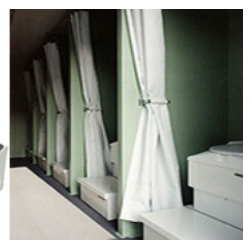
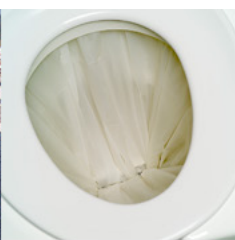

# PACTO TOILET

---

## – The unique system without the requirement for water and electricity

With more than 40 years in the portable toilet industry, the Pacto toilet is a well tested and reliable system. It does not require connections for electricity, water or to the main sewer system. Instead of water, an environmentally friendly flush foil lining is used to encapsulate waste, avoiding direct contact by the user.

Due to its design and function, the Pacto is very versatile. It is a popular choice in areas where many people gather and in environments with high requirements of sanitation, hygiene, user-friendliness and well thought-out functions. The toilet can be used in any weather conditions in any climates.

The Pacto Toilet is compact and easy to handle, making it ideal for contingency planning and can be set up for use within minutes. With no sewerage, electricity, water, or chemical treatment required, the Pacto provides a ready answer wherever conventional toilet facilities are unavailable. The waste from the Pacto is securely and hygienically double wrapped and stored for disposal later.

## – Applications

Pacto is used in areas with limited access to water and sewerage, for example:

- Remote camps for scientific project, resource exploration, drilling crews and environmental clean-ups
- Mines
- National park resorts
- Ski areas
- Cottages
- Field camps and fields hospitals
- Military operations
- Contingency planning for natural disasters

## – Flush foil liner

In lieu of water, the Pacto toilet uses a specially developed flush foil liner to encapsulate waste. The flush foil comes in two versions; an ecological compostable (aimed for use in cottages) and one made from polyethylene (Type A).

The ecological flush foil is made of corn starch and is fully biodegradable when composted together with household and/or garden waste. In a well-functioning household and garden, the compost film breaks down in about 6 months. The degradation in a pure latrine compost is delayed. The shelf life when stored is about 2 years. The product is perishable and should be stored in a cool, dark and dry place. Storage in other conditions shortens the life span of the unused flush foil.

The Type A flush foil liner is manufactured from very durable polyethylene, ensuring safe transportation of the waste content. The flush foil can be incinerated after use, leaving only carbon dioxide and water.

## – Advantages with the Pacto

- No water needed
- No sewerage needed
- No electricity needed
- No contact with waste
- Environmentally friendly
- Easy to assemble
- Easy to move
- Robust and durable

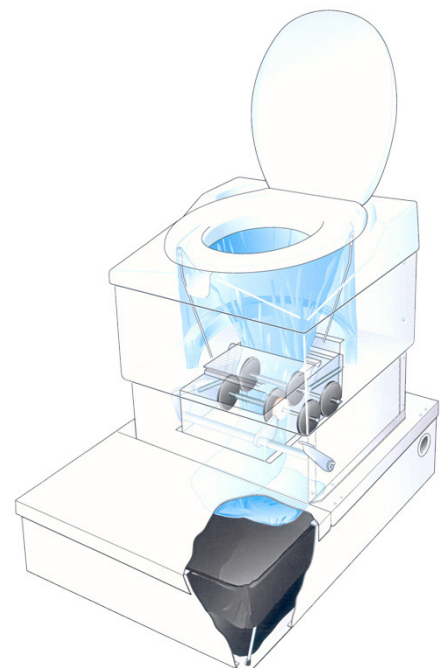

## START UP

### – Easy to assemble

The Pacto toilet is easy to store and can be set up within minutes. When delivered, the telescopic toilet is collapsed for facilitate transportation, but is easily reassembled in a few simple steps.

## HYGIENE

### – No waste contact

Instead of water, a pedal fed flush liner is used, ensuring a clean toilet bowl and hygienic visit at all times.

Removing the encapsulated waste from the Podium is easy and hygienic.

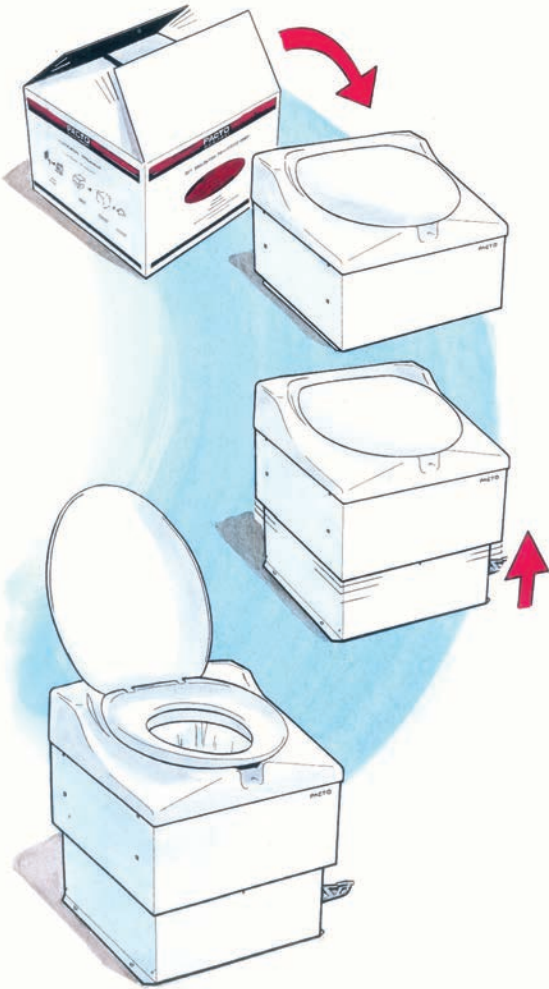

*Earthquake in Turkey 1999*



*Pacto in a cabin, ski area Switzerland*

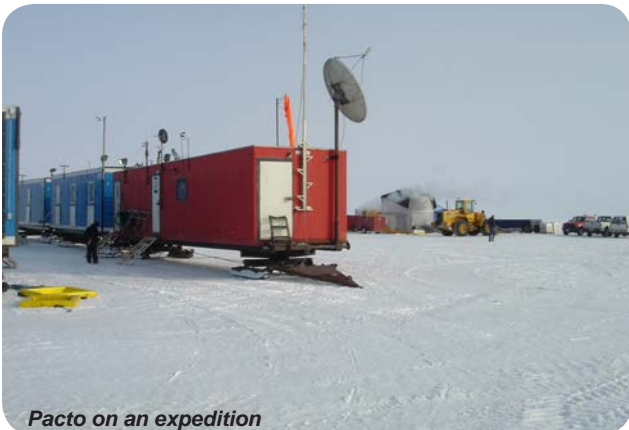

*Pacto on an expedition*



*Pacto in a tent*



*In a shelter for field operations*

## INSTALLATION 1

### – Installation with Podium

To install the toilet fasten it to the Podium that will contain the waste bags, see picture below.

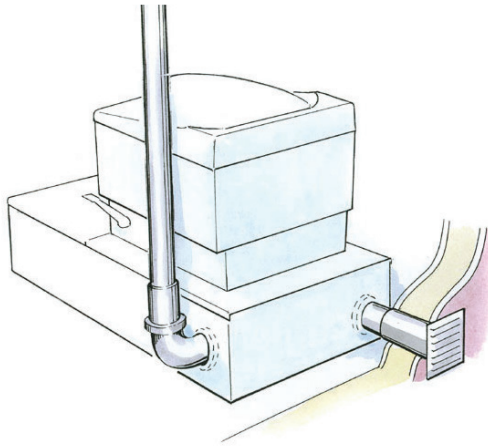

## INSTALLATION 2

### – Installation with separate waste container

The Pacto Toilet can also be used with a separate waste container arrangement adapted as shown below.

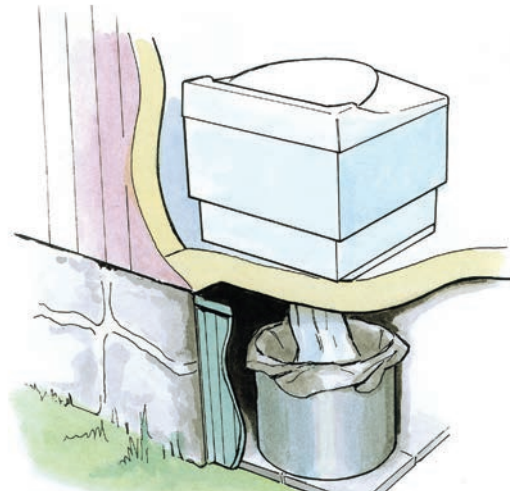

## FLUSH FOIL

### Type A Polyethylene flush foil

- One box contains 5 cassettes of flush foil liner and 15 black waste bags
- Each cassette is 39 metres long
- One box allows for approx. 1500 flushes

### Ecological flush foil

- One box of flush foil liner contains 1 cassette of flush foil liner, 5 ecological waste bags and 1 black waste bag
- Each cassette is 40 metres long
- One box allows for approx. 300 flushes

## DIMENSIONS AND WEIGHT

### Pacto Toilet

Depth: 484 mm / 19 in  
Width: 483 mm / 19 in  
Height: 415\* mm / 16 in  
Weight: 16 kg

\* height of seat

### Podium (waste container)

Depth: 817 mm / 32 in  
Width: 560 mm / 22 in  
Height: 219 mm / 8.6 in  
Weight: 21 kg



Danfo AB | Box 103 | 713 23 Nora, Sweden | Tel: +46 587 861 00

info@danfo.com | www.danfo.com | www.pactotoilet.com